



RAJHANS[®] [®] [©]



Architectural
Hardware Products



A Leading Manufacturer of
Drawer Slides,
Soft Close Auto Hinges
& Kitchen Products

www.rajhanstechnocraft.com



PROFILE

Rajhans Technocraft (An ISO 9001:2015 Certified Company) started its business in the year 2015 as a partnership firm in the Industry. In the short span of time, we have successfully achieved an eminent position in the Industry. We providing wide range of Telescopic Channel, Auto Hinges, Gas Spring, Tendon Box Drawer System, Kitchen Accessories, Bed lifter, Foldable Table Brackets, Wardrobe Sliding Door System, Wardrobe accessories, Multipurpose Lock, Tubular Lock with **RAJHANS** brand. The **RAJHANS** has captured the hearts of the consumers across the nation and based on popular demand it has been slowly adding new products and services to its portfolio. Our product range manufactured using high grade raw material such as Cold Rolled Steel (CRC) and Stainless Steel, and are widely appreciated for application specific design, durability and tensile strength. We use excellent quality basic materials and cutting edge technology to manufacture these products. Smooth surface, metal finish, cost effective rates and quality assurance are the few of the factors that make our customers love our offered products.

Our products are acknowledged for the following features finest finish, durability, anti-corrosion, long life, reliable etc. Our wide range helps the clients to choose the best product, in quality and design. Since our foundations, we are engaged in offering best quality handles to our customers and emerged as best option in the market to our patrons. We are working under the leadership of Mr. Bhavin Sorathia and Mr. Nirav Sorathia.



QUALITY

Rajhans Technocraft take every possible measure to maintain the highest quality standards. We use high quality raw material in the manufacturing of the products as per ISO standards. We use excellent quality basic materials and cutting edge technology to manufacture these products. Smooth surface, metal finish, cost effective rates and quality assurance are the few of the factors that make our customers love our offered products. Our quality controllers examine the offered range against predefined parameters of quality to offer a defect-free range and to achieve maximum client satisfaction. Quality analysts closely monitor the range, and use advance testing facilities to ensure all products are completely defect free.

RAW Material Inspection :

All materials are inspection for mechanical and chemical properties by verifying their certificates as per established norms.

DRAWER SLIDES

Premium Drawer Slides



Features :

Available length 8" to 24".
Available in Zinc & Black finish.
Material harden cold rolled steel.
Loading capacity up to 45 kg/pair.
Suitable for all kind of Furniture.

Packing : 15 Sets / Carton

Economy Drawer Slides



Features :

Available length 10" to 24".
Available in Zinc & Black finish.
Material harden cold rolled steel.
Loading capacity up to 35 kg/pair.
Suitable for all kind of Furniture.

Packing : 15 Sets / Carton

Stainless Steel Drawer Slides



Features :

Available length 10" to 24".
Material Stainless Steel.
Rust Free SS cage & SS Metal Balls.
Loading capacity up to 40 kg/pair.
Suitable for all kind of Furniture.

Packing : 15 Sets / Carton

Soft Close Drawer Slides



Features:

Available length 10" to 24".
Available in Zinc Finish.
Material harden cold rolled steel.
Smooth & Silent Locking system.
Loading capacity up to 40 kg/pair.
Suitable for all kind of Furniture.

Packing : 15 Sets / Carton

S.S. Soft Close Drawer Slides



Features:

Available length 14" to 20".
Material Stainless Steel.
Smooth & Silent Locking system.
Loading capacity up to 40 kg/pair.
Suitable for all kind of Furniture.

Packing : 15 Sets / Carton

Heavy Duty Slides (Sumo Slide)



Features:

Load Capacity : 110kgs
Finish : Double Zinc Plated
Length : 12" to 36",
Slide Width : 53mm
Thickness (mm) : 2.0 x 1.8 x 1.8 mm

Packing : 5 Sets / Carton

CABINET HINGES

Regular Hinges (M.S.)



Available : Full Overlay (Crank - 0), Half Overlay (Crank - 8) Insert(Crank - 15)
Packing : 100 Sets / Carton

Regular Hinges (S.S.)



Available : Full Overlay (Crank - 0), Half Overlay (Crank - 8) Insert(Crank - 15)
Packing : 100 Sets / Carton

Slip On Soft Close Hinges (M.S.)



Available : Full Overlay (Crank - 0), Half Overlay (Crank - 8) Insert(Crank - 15)
Packing : 100 Sets / Carton

Slip On Soft Close Hinges (S.S.)



Available : Full Overlay (Crank - 0), Half Overlay (Crank - 8) Insert(Crank - 15)
Packing : 100 Sets / Carton

Eco Series Soft Close Hinges (M.S.)



Available : Full Overlay (Crank - 0), Half Overlay (Crank - 8) Insert(Crank - 15)
Packing : 50 Sets / Carton

Eco Series Soft Close Hinges (S.S.)



Available : Full Overlay (Crank - 0), Half Overlay (Crank - 8) Insert(Crank - 15)
Packing : 50 Sets / Carton

CABINET HINGES

Premium Soft Close Hinges (M.S.)



Available : Full Overlay (Crank - 0), Half Overlay (Crank - 8) Insert(Crank - 15)
Packing : 50 Sets / Carton

Premium Soft Close Hinges (S.S.)

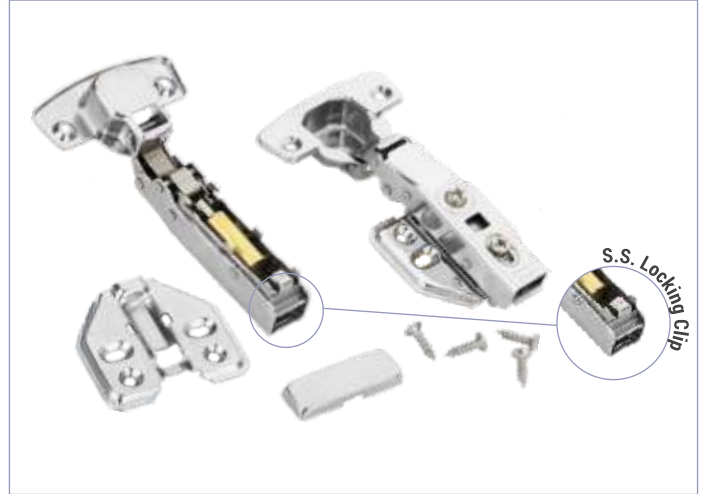

Available : Full Overlay (Crank - 0), Half Overlay (Crank - 8) Insert(Crank - 15)
Packing : 50 Sets / Carton

3D Soft Close Hinges (M.S.)



Available : Full Overlay (Crank - 0), Half Overlay (Crank - 8) Insert(Crank - 15)
Packing : 50 Sets / Carton

3D Soft Close Hinges (S.S.)



Available : Full Overlay (Crank - 0), Half Overlay (Crank - 8) Insert(Crank - 15)
Packing : 50 Sets / Carton

3D Soft Close Hinges (Black)



Available : Full Overlay (Crank - 0), Half Overlay (Crank - 8) Insert(Crank - 15)
Packing : 50 Sets / Carton

Thick Door Soft Close Hinges



Available : Full Overlay (Crank - 0), Half Overlay (Crank - 8) Insert(Crank - 15)
Packing : 50 Sets / Carton

CABINET HINGES

165 Degree (Corner Hinges)



Packing : 50 Sets / Carton

165 Degree Soft Close (Corner Hinges)



Packing : 50 Sets / Carton

135 Degree (Pie Hinges)



Packing : 50 Sets / Carton

SHORT ARM HINGES

2D Short Arm Hinges (M.S.)



Available In : Half Overlay (Crank - 8)

Packing : 100 Sets / Carton

3D Short Arm Hinges (M.S.)



Available In : Half Overlay (Crank - 8)

Packing : 100 Sets / Carton

3D Short Arm Hinges (S.S.)

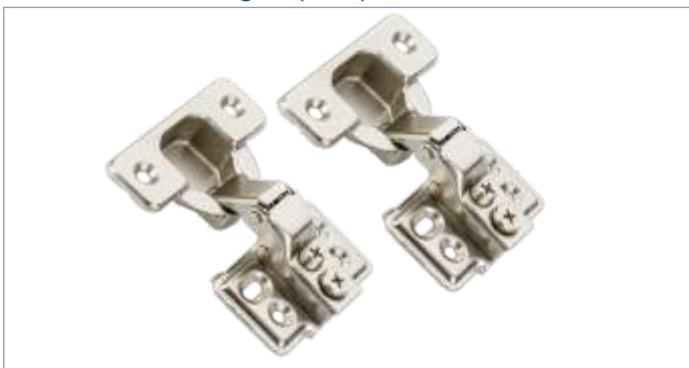

Available In : Half Overlay (Crank - 8)

Packing : 100 Sets / Carton

3D Soft Close Short Arm Hinges (S.S.)



Available In : Full Overlay (Crank - 0)

Packing : 100 Sets / Carton

GAS SPRING, BED LIFTER & FOLDABLE TABLE BRACKETS

GAS SPRING



10 inch (Silver)

Capacity : 5kg, 10kg, 15kg, 20kg
Packing : 50 Sets / Carton



12 inch (Black)

Capacity : 10kg, 15kg, 20kg, 25kg, 30kg
Packing : 25 Sets / Carton

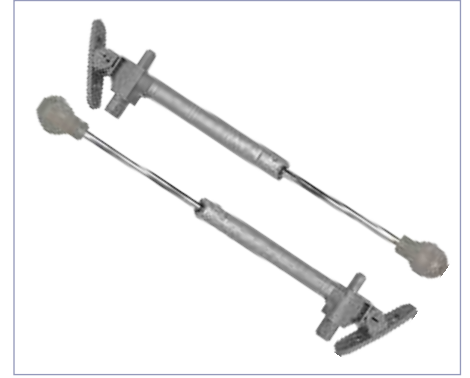

10 inch Soft Close

Capacity : 5kg, 10kg, 15kg
Packing : 25 Sets / Carton

PREMIUM BED LIFTER



Features :

Easy to lift installation
5mm heavy bed frame
17 inch heavy gas pump
Easy to lift the weight of the top board of bed with minimum force

Available : 3 Feet, 4 Feet & 5 Feet

FOLDABLE TABLE BRACKETS



Load Capacity :
100kgs to 150kgs.

Available :
12", 16", 20", 24"

Features :
Ideal fitting for a fold away table.
Special release latch helps fold the table.
Built for strength and durability.
Available in Powder Coated Grey

17" HEAVY GAS PUMP



Available : 75kg, 100kg, 125kg, 150kg, 175kg, 200kg, 225kg, 250kg

LOCK SERIES

Multipurpose Lock (Regular)



Available : M.S. Body, M.S. Key
Packing : 12pcs Inner Box, 20 Inner Box in Carton (240pcs/Carton)
Application : For Modular Furniture Drawers

Wardrobe / Drawer Lock (Premium)



Available : S.S. & M.S. (Brass Cylinder, Brass Ultra Key)
Packing : 12pcs Inner Box, 20 Inner Box in Carton (120pcs/Carton)
Size : 32mm, 22mm
Application : For Wardrobe Drawer & Cupboard

Tribolt Lock



Features

14 Pins 29 mm Brass Cylinder With Ultra Keys
Mechanically Strong & Robust Design
Smooth Movement
Superior Finishes ensures Longer Life
Single Side / Both Side Heavy Duty Key Locking System

Contents

1 Pc. Lock Set
1 Pc. Cylinder Set
1 Pc. Ring
1 Pc. Screw Set

Finish

S.S.
Antique Brass

Penta Bolt Lock



Finish
S.S.
Antique Brass

Tubular Lock (S.S. & Antique Brass)



Available : Brass Key & Without Keys
Packing : 30 Sets / Carton
Finish : S.S. & Antique Brass

WARDROBE SLIDING SYSTEM, DOOR CLOSER & FLOOR SPRING

WARDROBE SLIDING SYSTEM



Universal

Specification

- Soft Closing System with anti-jump and automatic hook coupling function
- Loading capacity per door: 50kg
- Apply to the thickness of wooden door : T<20mm
- Comfortable and safe soft closing function, best silent and smooth performance

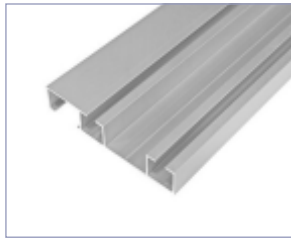
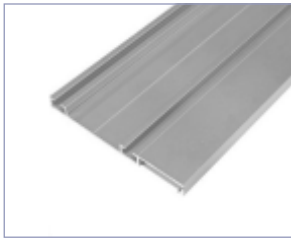
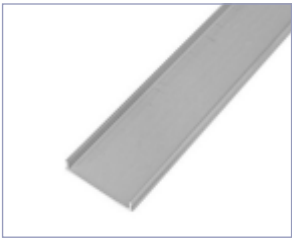

Top / Back Screw

- Visible roller design for external fixing , no need make groove on the furniture
- Concealed damper - Original design, Automatic position pre-setting and easy installation of dampers
- improve the level of furniture and expand the life of furniture
- Apply to panel wood, solid wood and aluminum frame door

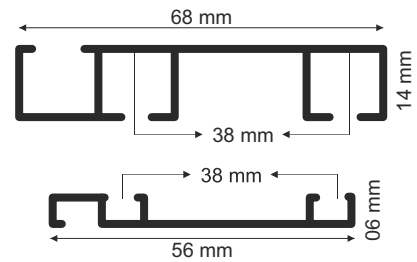

DOOR CLOSER



Regular

Packing : 10 Sets / Carton
Capacity : 35kg - 65kg



Heavy Duty

Packing : 10 Sets / Carton
Capacity : 35kg - 80kg



Concealed

Packing : 10 Sets / Carton
Capacity : 35kg - 65kg

FLOOR SPRING (For Wooden Door)

Regular - SILVER



Capacity : Up to 90kg
Hold-Open Point : 90 degree
Packing : 4 Sets / Carton

Heavy Duty - GOLD



Capacity : Up to 120kg
Hold-Open Point : 90 degree
Packing : 4 Sets / Carton

DRAWER BOXES (Tendom Boxes)

3D - SLIM TENDOM BOX



This is used in modular kitchen which have special sliding mechanism.

Features :

Concealed full extension soft closing drawer

Silent system smooth run without noise

3D adjustment, up & down (+2mm), left & right (+1.5mm) and front panel tilt adjustment.

Self and soft-closing function make the drawer close safety without effect of weight.

Lengths : 350mm to 600mm

Height : 90mm, 121mm, 171 mm

Color : Dark grey

Capacity : 45kgs

Packing : 6 Sets / Carton

3D - QUADRO SLIDES (Undermount Slide)



Features:

Silent, Smooth and Soft closing.

High quality stainless steel buffer

Different function with different material of accessories inside the slide: POM, Nylon and ABS.

Drawer closing time: Can be fixed according to customer requirement.

Widely using for kitchen baskets.

Usage : Wardrobe drawers

Capacity : 35kgs

Lengths : 300mm, 350mm, 400mm, 450mm, 500mm, 550mm

SMART SLIM DRAWER BOX (Glass)



Features :

Lengths : **450mm, 500mm, 550mm.**

Full Extension.

Integrated 3D front adjustment.

Easy, Quick installation and precise alignment.

Silent & Ultra smooth soft closing runner.

Available Size:

Height 106mm

Height 132mm

Height 162 mm

Color : Dark Grey

Packing : 6 Sets / Carton

DRAWER BOXES & KITCHEN ORGANIZER

REGULAR DRAWER BOX



Features :

- Lengths : 450mm / 500mm / 550 mm.
- Full Extension.
- Integrated 3D front adjustment.
- Easy, Quick installation and precise alignment.
- Silent & Ultra smooth soft closing runner.

Available Size :

- 90mm
- Universal gallery set (Adjusted at any height)

Color : Light Grey

Packing : 6 Sets / Carton

PULL OUT DRAWERS



Features:

Two layer shelf, Three layer shelf,
Adjustable basket position
Toughened Glass Basket
Left and Right option

Available Size :

200 mm

250 mm

300 mm

Carcase Dimension

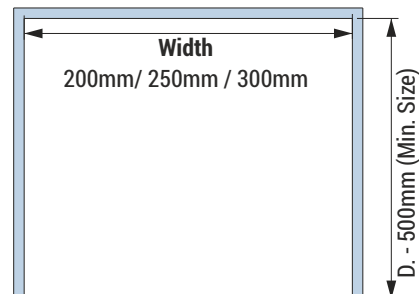

Cabinet Size (W)	Basket Dimension (W x D x H) mm
200 mm	130 x 470 x 80
250 mm	170 x 470 x 75
300 mm	200 x 470 x 75

TALL PANTRY UNIT



Feature :

More choice of basket style. offer customers many choice of variants featuring exclusive design.

Soft-close design available.

Max 5kgs for each big basket and 3kgs for small basket.

The height of frame can be adjusted, the distance between basket can be changed.

Available Cabinet Sizes :

450 mm

600 mm

Available Finish : Toughened Glass Line Basket

Layers	Cabinet Size	W D H (mm)
6	450 mm	386 x 500 x 1900 - 2160
6	600 mm	486 x 500 x 1900 - 2160

Carcase Dimension

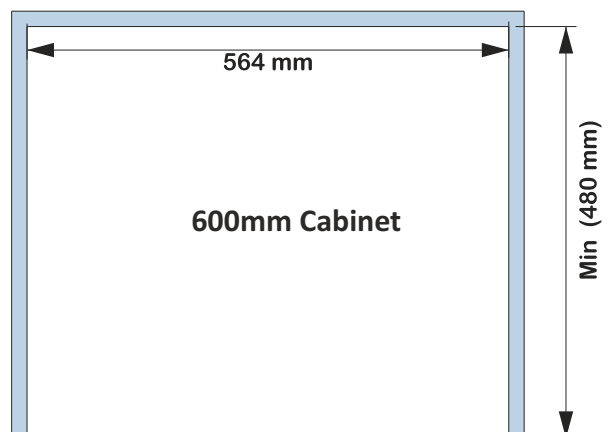
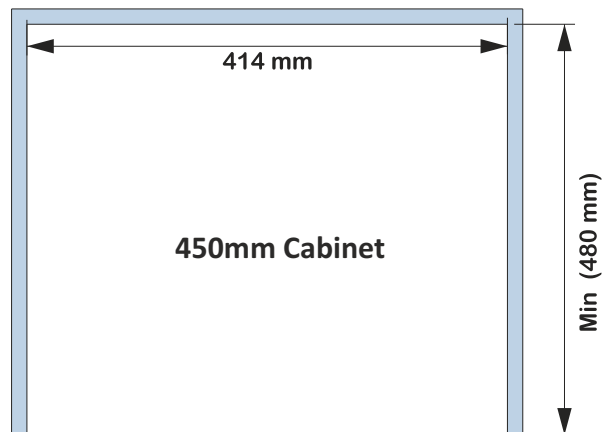

KITCHEN ORGANIZER

SWING CORNER



Features :

Anti -Skid Finish
 Max 10kgs for each swing tray.
 The pole height, tray's Qty and tray distance could be adjusted.

Available Finish :

Chrome Finish
 Steel Grey

Dimension

Cabinet Width (A)	1050mm - 1100 mm
Cabinet Depth (B)	560mm (min)
Height (C)	600mm - 700 mm
Door Width (D)	450mm - 500 mm

Left Side

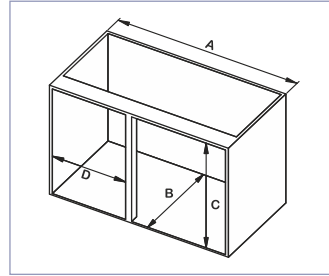

Right Side

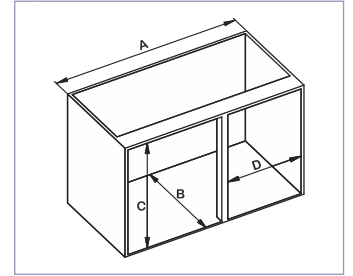

ROLLING SHUTTER (PVC & Glass)



White

Black

Sliver

Grey

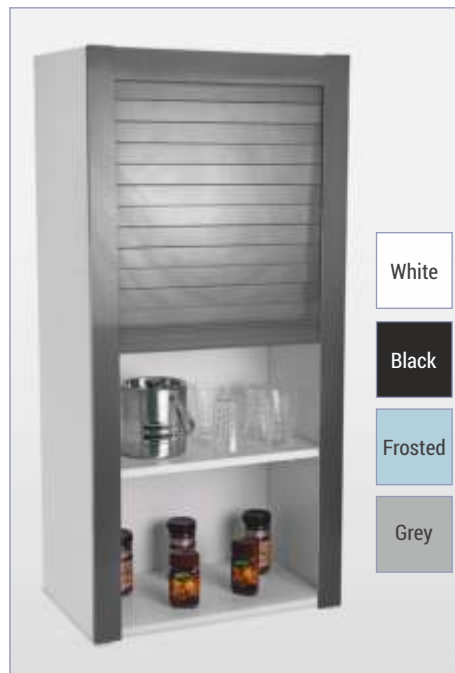

White

Black

Frosted

Grey

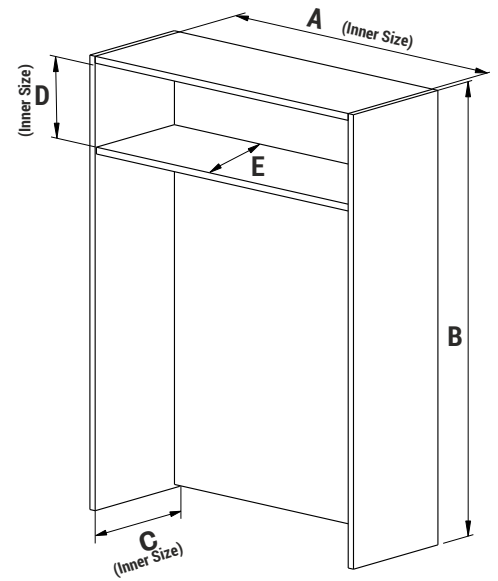

Available Sizes :

600mm (W) x 350mm (D) x 1400mm (H)
 900mm (W) x 350mm (D) x 1400mm (H)

PVC

PVC Cabinet Size

Size	A	B	C	D	E
600mm	564mm	1200mm	280mm	189mm	260mm
		1400mm			
900mm	864mm	1200mm	280mm	189mm	260mm
		1400mm			

Glass

Glass Cabinet Size

Size	A	B	C	D	E
600mm	564mm	1200mm	305mm	153mm	280mm
		1400mm			
900mm	864mm	1200mm	305mm	153mm	280mm
		1400mm			

KITCHEN ORGANIZER

SOFT CLOSE SHOW HAND CORNER (Universal Magic Corner)



Features :

- Toughened Glass Basket Option
- Easy to install in both side

Carcase Dimension (900 mm)

Cabinet	Size
Width (A)	1050mm - 1100mm
Depth (B)	560mm (Min.)
Height (C)	600mm - 700mm
Door Width (D)	440mm - 490mm

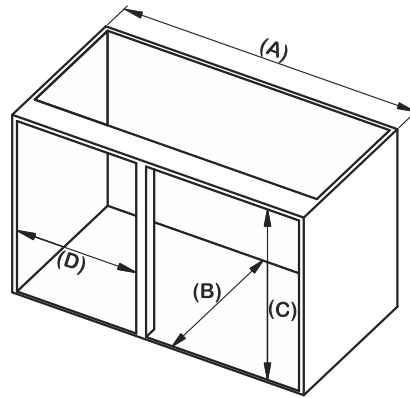

WICKER BASKETS



Finish :

- Light Brown
- Dark Brown

Uses :

- Kitchen
- Wardrobe

Width	450mm	600mm	900mm
Height	100mm	100mm	100mm
	160mm	160mm	160mm
	200mm	200mm	200mm

S.S. Plate Fixture & Cup Saucer Fixture



Available Cabinet Sizes : 450mm, 500mm, 550 mm, 600mm

ABS Plate Fixture & Cup Saucer Fixture

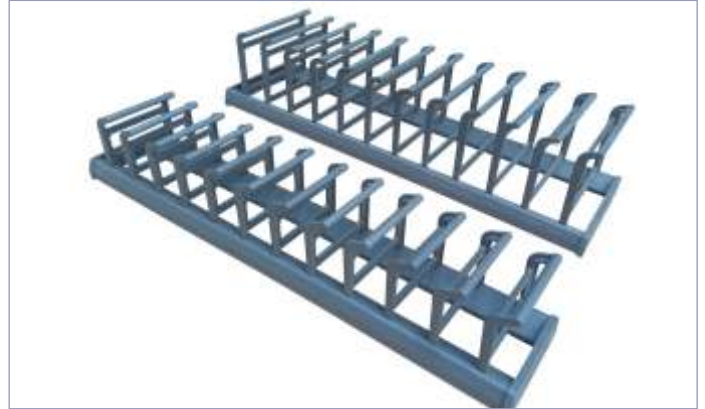

Available Cabinet Sizes: 500 mm, 550 mm

ABS Cutlery



Available Cabinet Sizes (W x D x H)

380mm x 480mm x 60mm	830mm x 480mm x 60mm
430mm x 480mm x 60mm	430mm x 550mm x 60mm
530mm x 480mm x 60mm	530mm x 550mm x 60mm
630mm x 480mm x 60mm	630mm x 550mm x 60mm
730mm x 480mm x 60mm	730mm x 550mm x 60mm

Anti Skid Mat



Available Cabinet Sizes

- 500mm x 5mtr.
- 500mm x 20mtr.
- 550mm x 5mtr.
- 550mm x 20mtr.

Waste Bin (SS / PVC)



Size : 10 Ltr. Capacity

Specification

- Automatic Opening System for Lid
- Hassle free and easy removal of container
- Flexible & Compact
- Aesthetic Design

DOOR HINGES

Premium Hinges



Ball Bearing Hinges



GTPT (S.S.) (Glass Tray Plate Tray)



Type	Size
Welded	75 x 19 x 13
	75 x 18 x 18
	3 x 16
	3 x 12
	4 x 14
	5 x 14
	4 x 12
	5 x 12
	4 x 10
5 x 10	

Type	Size
Bearing (4BB)	4 x 3 x 3
	5 x 3 x 3

Available Finish :

- S.S.
- Antique Brass

Features :

SS Designed for a special wet coastal areas with high quality anit-rusty functions.

Cabinet Size	W D H (mm)
600 mm	565x280x(100+45)
700 mm	665x280x(100+45)
800 mm	765x280x(100+45)
900 mm	865x280x(100+45)
1000 mm	965x280x(100+45)



Trouser Rack REC

Size : 600mm, 900mm



Leather Jewellery Box

Size: 600mm, 900mm

WARDROBE ACCESSORIES



Glass Basket

Size : 600mm, 900mm



Rattan Basket

Size : 600mm, 900mm



Trouser Rack + Jewellery Tray

Size : 350mm to 600mm



Shoe Rack Sheet Base

Size : 600mm, 900mm



360 Degree Rotating Shoe Rack

Size : 700mm x 360mm x 1910mm - 2110mm (12 Layers)

WARDROBE ACCESSORIES



Trouser Rack Double Line

Size : 630mm x 455mm x 115mm



Trouser Rack Single Line

Size : 340mm x 455mm x 140mm



Cloth Holder

Size : 115mm x 455mm x 115mm



Wardrobe Lifter (Duo Soft Close) 17 kg

Wardrobe Lifter (Soft Close) 13 kg

Size : 830mm-1150mm



Modular Pull Out Mirror

Size : 1000mm x 350mm



Ironing Board

Size : 295mm x 430mm

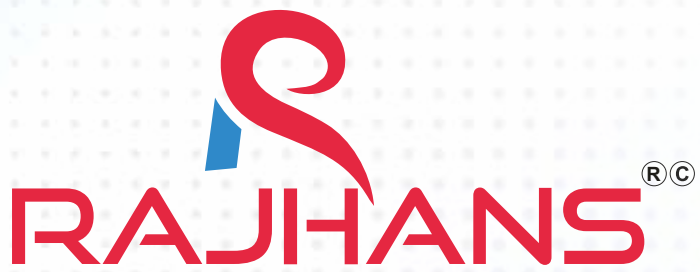

Authorised Distributor



RAJHANS TECHCRAFT

📍 Survey No. 166, Plot No. 93-94-95,
Hari Om Industrial Area,
Ahmedabad Gondal Bypass Circle,
Kothariya, Rajkot (Guj.) - 360 004, INDIA

☎ +91 89489 47647
✉ info@rajhanstechnocraft.com
🌐 www.rajhanstechnocraft.com